

A Study of Intake System Noise Transmission with Porous Insulator Using Statistical Energy Analysis

M. H. Shojaeefard¹, R. Talebitooti^{*,2}, M. Amirpour Molla³ and R. Ahmadi⁴

¹ Prof, Mechanical Engineering Department, Iran University of Science and Technology, ² Assitant Professor, Automotive Engineering Department ,Iran University of Science and Technology, ³ Ph.D Student, Mechanical Engineering Department, Tarbiat modares University, ⁴ Ph.D Student, Automotive Engineering Department, Iran University of Science and Technology.

* Corresponding Author

Abstract

Automobile manufactures are persistently trying to enhance passenger comfort with improving different specifications such as reduction of sound level in an air intake system of motorcar engine.

This work uses statistical energy analysis (SEA) to study noise transmission loss (TL) and sound pressure level (SPL) through intake system of an engine. Porous material is used at duct wall in order to reduce air resonance in the air intake duct. In addition, the effects of porous materials on noise transmission loss through duct of intake system of engine are studied.

Firstly, the SEA model of simple duct is constructed in AutoSEA2 software, and then the results are compared with those of analytical model: this confirms the accuracy of this SEA model in a high frequency range. Finally, the detailed model of air intake system treated with porous materials is analyzed using AutoSEA2 software.

Keywords: Air intake system, SEA, porous material, Transmission Loss

1. INTRODUCTION

Noise transmission in motor vehicles can be difficult to study due to complexity of the vehicle structure. At high frequency, intake noise can be a problem in motor vehicles. In frequencies above 250 Hz, SEA can be used to study noise transmission. Earlier work has shown that structural vibration transmission can be fairly predicted for some vehicles using SEA [1-3].

Milstead reviewed the literature on engine noise and noted problems in characterizing vibration sources on engines [4]. Priede also identifies many difficulties in predicting noise transmission from engines [5]. Wood and Joachim describe engine noise which can vary by 10 dB between nominally identical vehicles [6]. Slevewright described the noise problem of an air intake manifold [7]. In recent years, elastic porous materials such as foams have been increasingly used for passive control of automobile interior noise. While multi-panel structures lined with porous materials are found in many practical applications as mentioned above, an analysis of sound transmission through such structures remains as a very difficult task.

The resonator is a kind of silencer that absorbs noise of engine air intake system. Tow or three resonators are used to reduce the resonance noise in

the air duct. The number of resonators should be decreased in order to save the space, cost and weight. The duct with porous material is one of the new items to reduce the noise in air intake system. However, this method has a problem of balancing between cost and weight. Therefore the modeling and simulation of this material is of high interest for engineers to achieve two goals; noise and cost reductions.

In this paper, in the first step, sound transmission through a double-walled duct with a porous liner of infinite extents, is solved based on the full theory. In the second step, the acoustical modeling of this structure is explained by the aid of SEA method. Moreover the computer-based model is developed by the use of AutoSEA2 software.

The results from the SEA model are compared with analytical model based on the Biot's theory. The model of intake system is imported to AutoSEA2 software and then is divided into proper subsystems. The sound transmission loss and sound pressure level obtained from software are compared with experimental results. Finally, the influence of inserting porous material and effective parameters of the porous material such as thickness on the transmission loss and sound pressure level is studied.

2. ANALYSIS OF SOUND TRANSMISSION LOSS THROUGH SIMPLE DUCT LINED WITH ELASTIC POROUS MATERIAL USING SEA AND ANALYTICAL METHOD

2. 1. Analytical method

Figure 1 shows a schematic of the double walled duct lined with a porous layer subjected to a plane wave with an incidence angle γ . The thickness, the material density, the flexural stiffness per unit width, and the mass per unit area are $\{h_i, \rho_i, D_i, m_i\}$ and $\{h_e, \rho_e, D_e, m_e\}$ in which the subscripts i and e represent the internal and external shells. The thickness of a layer of porous material that is inserted between the shells is h_c . The mass density and sound speed of the acoustic media in the incident and transmitted sides are $\{\rho_1, c_1\}$ and $\{\rho_3, c_3\}$ respectively. In the external space, the wave equation becomes (Kinsler et al., 1982):

$$c_1^2 \nabla^2 (P^I + P_1^R) + \frac{\partial^2 (P^I + P_1^R)}{\partial t^2} = 0 \tag{1}$$

where P^I and P_1^R are the acoustic pressure of the incident and reflected waves. ∇^2 is the Laplacian operator in the cylindrical coordinate system. The wave equations in the fluid phase of the porous layer

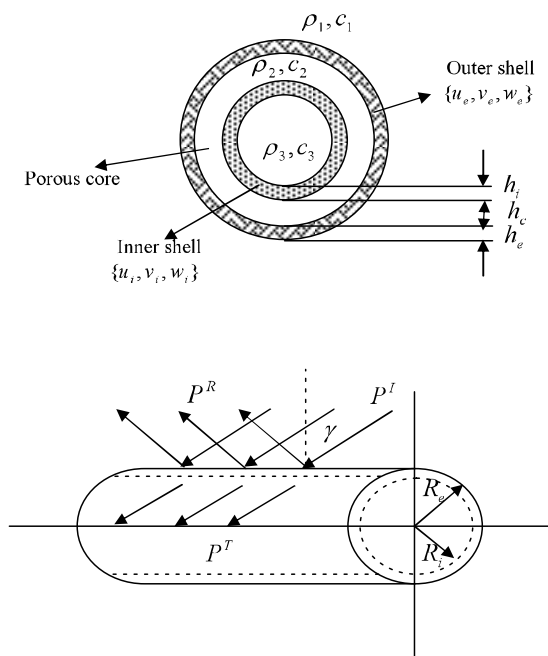

Fig. 1. Illustration of wave propagation in the simple double-walled duct lined with a porous material

and internal space are the same form as Equation (1) but with different variable indexes. The duct motions are described by Love's equations in (Soedel, 1993). Equations of motions in the axial, radial and circumferential directions of the inner and outer shell are [8]:

$$L_1 \{u_i^0, v_i^0, w_i^0\} = \rho_i h_i \ddot{u}_i^0 \tag{2}$$

$$L_2 \{u_i^0, v_i^0, w_i^0\} = \rho_i h_i \ddot{v}_i^0 \tag{3}$$

$$L_3 \{u_i^0, v_i^0, w_i^0\} + (P_2^T + P_2^R) - P_3^T = \rho_i h_i \ddot{w}_i^0 \tag{4}$$

$$L_1 \{u_e^0, v_e^0, w_e^0\} = \rho_e h_e \ddot{u}_e^0 \tag{5}$$

$$L_2 \{u_e^0, v_e^0, w_e^0\} = \rho_e h_e \ddot{v}_e^0 \tag{6}$$

$$L_3 \{u_e^0, v_e^0, w_e^0\} - (P_2^T + P_2^R) + (P^I + P_1^R) = \rho_e h_e \ddot{w}_e^0 \tag{7}$$

where L_1 , L_2 and L_3 are differential operators which can be found in reference. $\{u_i^0, v_i^0, w_i^0\}$ and $\{u_e^0, v_e^0, w_e^0\}$ represent the displacements of the inner and outer shell in the axial, circumferential and radial directions that are [9]:

$$u_i^0 = \sum_{n=0}^{\infty} u_{ni}^0 \cos(n\theta) \exp[j(\omega t - k_{3z} z)] \tag{8}$$

$$v_i^0 = \sum_{n=0}^{\infty} v_{ni}^0 \sin(n\theta) \exp[j(\omega t - k_{3z} z)] \tag{9}$$

$$w_i^0 = \sum_{n=0}^{\infty} w_{ni}^0 \cos(n\theta) \exp[j(\omega t - k_{3z} z)] \tag{10}$$

$$u_e^0 = \sum_{n=0}^{\infty} u_{ne}^0 \cos(n\theta) \exp[j(\omega t - k_{1z} z)] \tag{11}$$

$$v_e^0 = \sum_{n=0}^{\infty} v_{ne}^0 \sin(n\theta) \exp[j(\omega t - k_{1z} z)] \tag{12}$$

$$w_e^0 = \sum_{n=0}^{\infty} w_{ne}^0 \cos(n\theta) \exp[j(\omega t - k_{1z} z)] \tag{13}$$

In equations (11-13) k_1 , wave number in external

medium, is define as $k_1 = \frac{\omega}{c_1}$, $k_{1z} = k_1 \sin \gamma$, $k_{1r} = k_1 \cos \gamma$ and in equations (8-10) k_3 , wave number in internal cavity, is defined as $k_3 = \frac{\omega}{c_3}$, $h_{3z} = k_{1z}$, $k_{3r} = \sqrt{k_3^2 - k_{3z}^2}$.

The wave number, k_2 in the porous core calculates from the simplified method as suggested by Kim *et. al* [10].

The boundary conditions at the two interfaces between the shells and fluid are [11,12]:

$$\frac{\partial(P^I + P_1^R)}{\partial r} = -\rho_1 \frac{\partial^2 w_2^0}{\partial t^2} \quad \text{at } r = R_e \quad (14)$$

$$\frac{\partial(P_2^T + P_2^R)}{\partial r} = -\rho_2 \frac{\partial^2 w_1^0}{\partial t^2} \quad \text{at } r = R_i \quad (15)$$

$$\frac{\partial(P_2^T + P_2^R)}{\partial r} = -\rho_2 \frac{\partial^2 w_2^0}{\partial t^2} \quad \text{at } r = R_e \quad (16)$$

$$\frac{\partial(P_3^T)}{\partial r} = -\rho_3 \frac{\partial^2 w_1^0}{\partial t^2} \quad \text{at } r = R_i \quad (17)$$

The harmonic plane incident wave, P^I can be expressed in cylindrical coordinates as:

$$P^I(r, z, \theta, t) = P_0 e^{j(\omega t - k_{1z} z)} \sum_{n=0}^{\infty} \varepsilon_n (-j)^n J_n(k_{1r} r) \cos(n\theta) \quad (18)$$

where P_0 is the amplitude of the incident wave, $n=0,1,2,3,\dots$ indicates the circumferential mode number, $\varepsilon_n=1$ for $n=0$ and 2 for $n=1,2,3,\dots$, $j=\sqrt{-1}$ and J_n is the Bessel function of the first kind of order n .

Considering the circular cylindrical geometry, the pressures are expanded as:

$$P_1^R(r, z, \theta, t) = e^{j(\omega t - k_{1z} z)} \sum_{n=0}^{\infty} P_{n1}^R H_n^2(k_{1r} r) \cos(n\theta) \quad (19)$$

$$P_2^T(r, z, \theta, t) = e^{j(\omega t - k_{2z} z)} \sum_{n=0}^{\infty} P_{n2}^T H_n^1(k_{2r} r) \cos(n\theta) \quad (20)$$

$$P_2^R(r, z, \theta, t) = e^{j(\omega t - k_{2z} z)} \sum_{n=0}^{\infty} P_{n2}^R H_n^2(k_{2r} r) \cos(n\theta) \quad (21)$$

$$P_3^T(r, z, \theta, t) = e^{j(\omega t - k_{3z} z)} \sum_{n=0}^{\infty} P_{n3}^T H_n^1(k_{3r} r) \cos(n\theta) \quad (22)$$

where H_n^1 and H_n^2 are the Henkel functions of the first and second kind of order n .

Substitution of the expressions in equations (8) to (13) and (18) to (22) into six shell equations (equations

(2) to (7)) and four boundary conditions (equations (14) to (17)) yields ten equations, which can be decoupled for each mode if the orthogonally between the trigonometric functions are utilized. The transmission coefficient $\tau(\gamma)$ is the ratio of the amplitudes of the incident and transmitted waves. $\tau(\gamma)$ is a function of the incident angle γ defined by :

$$\tau(\gamma) = \sum_{n=0}^{\infty} W_n^T / W^I \quad (23)$$

where W^I is the incident power per unit length of the shells and W_n^T is the sound power transmitted per unit length of shell. To consider the random incidences, $\tau(\gamma)$ can be averaged according to the Paris formula [13]:

$$\bar{\tau} = 2 \int_0^{\gamma_m} \tau(\gamma) \sin \gamma \cos \gamma d\gamma \quad (24)$$

Where γ_m is the maximum incident angle, which is chosen between 70° and 80° as suggested by Mulholland *et al.* [14]. Integration of equation (24) is conducted numerically by Simpson's rule. Finally, the average TLs is obtained as:

$$TL_{avg} = 10 \log \frac{1}{\bar{\tau}} \quad (25)$$

2. 2. SEA Method

SEA method was first developed by Lyon [15] and others in the 1960's. Crocker *et al.* [16] used SEA to predict the sound transmission of isotropic single-layered panels. In this work, the same theoretical

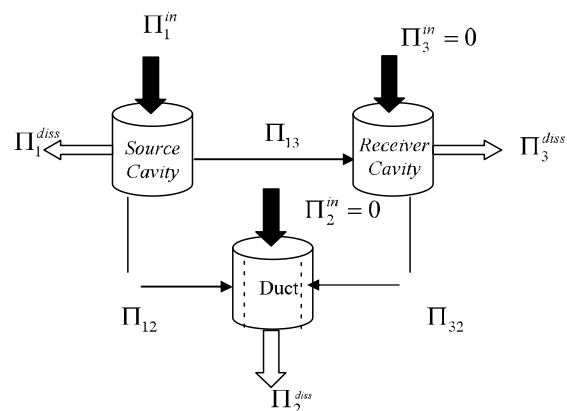

Fig. 2. Schematic of the power flow in three-coupled systems using SEA

model is used to predict the sound transmission loss for the simple duct lined with porous materials using the AutoSEA2 software. The subsystems and energy flow relationships are illustrated schematically in Figure 2. The source cavity and the receiving cavity are the first and the third subsystems, respectively and the duct under study is the second subsystem that a layer of noise-control treatment is applied on it.

If only the source cavity is excited using loudspeakers and there is no other power input to the other subsystems, the power balance equations can be expressed as [17-19]:

$$\Pi_2^{in} = \Pi_1^{diss} + \Pi_{12} + \Pi_{13} \quad (26)$$

$$\Pi_{12} = \Pi_2^{diss} + \Pi_{23} \quad (27)$$

$$\Pi_3^{diss} = \Pi_{13} + \Pi_{23} \quad (28)$$

Where Π_i^{in} , Π_i^{diss} and Π_{ij} are the power input to the i-th subsystem, the power dissipated in the i-th system and the power flow between subsystems i and j, respectively that for each subsystem can be written as:

$$\Pi_i^{diss} = E_i \omega \eta_i \quad (29)$$

$$\Pi_{ij} = \omega \eta_{ij} n_i \left(\frac{E_i}{n_i} - \frac{E_j}{n_j} \right) \quad (30)$$

where ω is the center frequency of the frequency band, n_i and n_j are the modal densities of subsystems i and j and η_{ij} is the coupling loss factor from subsystem i to subsystem j. The equation $\eta_{ij}/\eta_{ji} = n_j/n_i$ must be satisfied.

Applying equation (30) to equation (27) gives the power balance of the wall for resonance modes in a frequency band with the center frequency ω :

$$\Pi_{12} = \omega \eta_{21} n_2 \left(\frac{E_1}{n_1} - \frac{E_2}{n_2} \right) = E_2 \omega \eta_2 + E_2 \omega \eta_{23} \quad (31)$$

Note that generally the sound pressure level in the source cavity is significantly greater than in the receiving cavity, $E_3/n_3 \ll E_1/n_1$ so the E_3/n_3 term is neglected in equation (31).

$$\Pi_{13} = \omega \eta_{13} E_1 \quad (32)$$

In the source cavity, the sound power incident on the dividing partition of area A_p with pressure P_l is:

$$\Pi_{inc} = \frac{\langle P_l^2 \rangle}{4\rho c} A_p \quad (33)$$

So, the power radiated by the resonant modes into the receiving room is:

$$\Pi_{23} = \rho c A_p \sigma_{rad}^2 \langle v^2 \rangle \quad (34)$$

That σ_{rad} and $\langle v^2 \rangle$ represent sound radiation efficiency and averaged squared velocity of the shells respectively.

The transmission coefficient can be approximated by:

$$\frac{1}{\tau} = \frac{\Pi_{inc}}{\Pi_{23} + \Pi_{13}} = \frac{\frac{\langle P_l^2 \rangle}{4\rho c} A_p}{\rho c A_p \sigma_{rad}^2 \langle v^2 \rangle + \omega \eta_{13} E_1} \quad (35)$$

Then, the sound transmission loss TL can be calculated by:

$$TL = 10 \log(1/\tau) \quad (36)$$

It is common practice in the automotive industry to use a SEA based code called AutoSEA2 to predict noise level. AutoSEA2 uses SEA to analysis structural acoustic systems. The foam module in AutoSEA2, which is based on Biot's theory of porous media [20,21], was used to predict the structural acoustic effects of porous noise-control treatments. The SEA model consists of two thin, simply supported shells separated by a porous layer. The double-shell separated two adjacent 3D acoustic cavities. One of them was source cavity while the second one was the receiver cavity. The source acoustic cavity resembles the reverberation room, and the receiver acoustic cavity resembles the anechoic chamber. The external excitation is generated by the diffuse source field located in the source cavity. The shell and the acoustic cavities are connected by an SEA area junction. For the purpose of the energy flow analysis and prediction of transmission loss, the SEA model is developed. The SEA model and acoustical area junction are presented in the Figure 3. The dimensions and physical properties for each subsystems of SEA model are listed in table 1, 2.

Then, the model is solved to obtain transmission

Table1. Dimensions and physical properties of three subsystems

Subsystems	Radius(mm)		Technical Data
Source Cavity	---		Material =Air Damping Loss Factor (η) = 0.001 $c = 342$ m/s Density (ρ_0) = 1.21 kg/m^3
Double cylindrical shells Lined with Porous Material	Length = ∞	Inner Shell $R_i = 0.2m$	Table 2
		Foam Layer	
		Outer Shell $R_o = 0.15m$	
Receiving Cavity	---		Material =Air Absorption Coefficient (α) = 1 $c = 389$ m/s Density (ρ_0) = 0.94 kg/m^3

Table 2. Physical properties of double- shells (different layers)

Parameters	Inner Shell	Porous Layer	Outer Shell
Thickness, (m)	0.003	0.0475	0.002
Porosity, h	----	0.9	----
Flow resistivity, $\sigma(Nm^{-4}s)$	----	$2.5 \text{ e } 4$	----
Tortuosity, α_∞	----	7.8	----
Viscous charact. dim, $\Lambda(m)$	----	$2.26 \text{ e } -4$	----
Thermal charact. dim, $\Lambda'(m)$	----	$2.26 \text{ e } -4$	----
Density of Frame, $\rho(kg m^{-3})$	2700	30	2700
Young's Modulus, (Pa)	$7.1 \text{ e } 10$	$8.008 \text{ e } 5$	$7.1 \text{ e } 10$
Shear Modulus, (Pa)	$2.67 \text{ e } 10$	$2.86 \text{ e } 5$	$2.67 \text{ e } 10$
Poisson coefficient, ν	0.3	0.4	0.3
Structural Damping, η	0.007	0.265	0.007

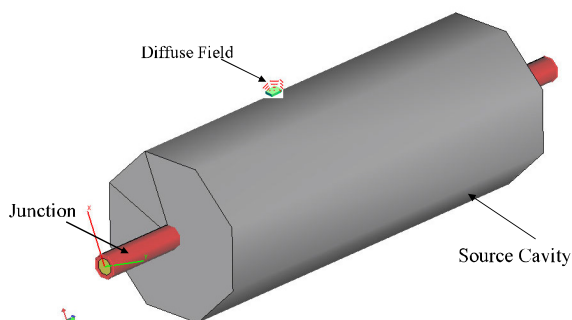

Fig. 3. AutoSEA2 model with acoustical area junction

loss considering the noise-control treatment. The frequency range of analysis is from 100 Hz to 5000 Hz in a one-third octave domain. The porous layer is assumed to be perfectly bonded to the panels.

2. 3. Comparison Between Analytical and SEA Methods

Parametric numerical studies of Transmission Loss (TL) are conducted for a double-walled cylindrical shell lined with porous material, considering 1/3 octave band frequency. The modal density is one of



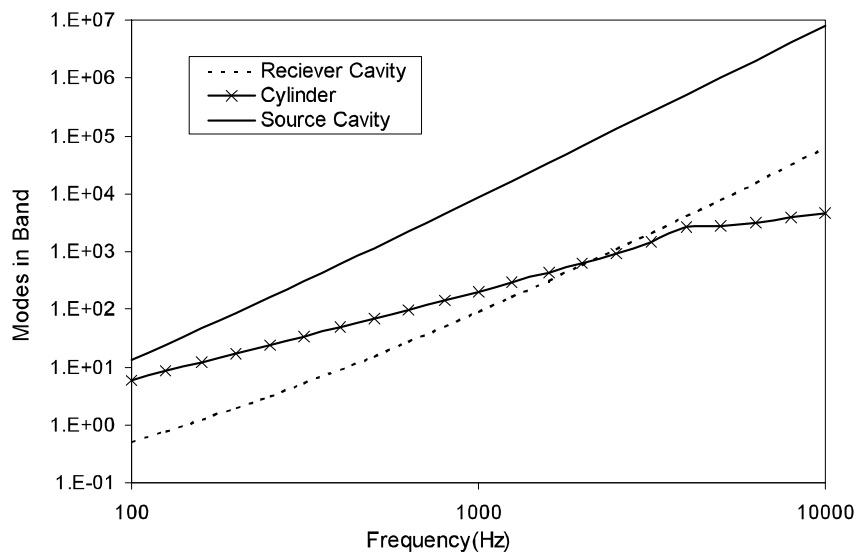

Fig. 4. The number of modes in a band for SEA model

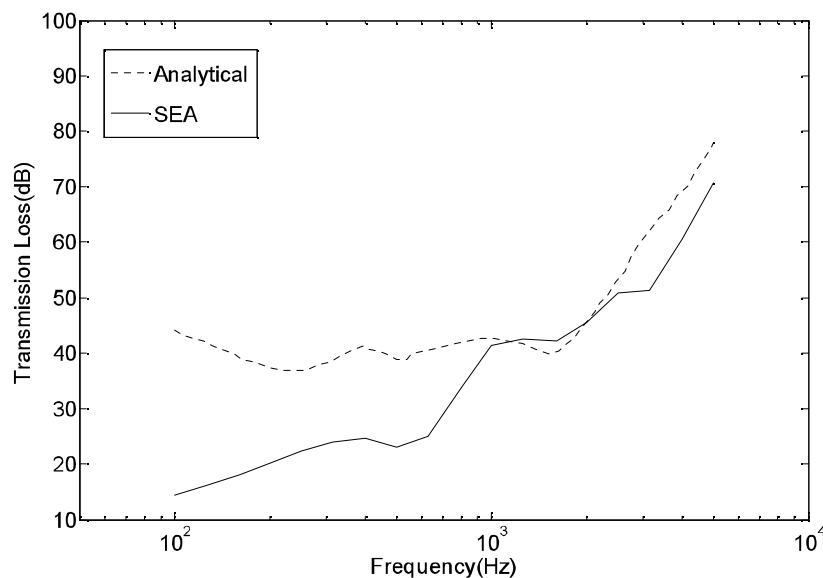

Fig. 5. Comparison of the SEA model and analytical method for double-walled cylindrical shell with a bounded porous layer

the basic parameters used in SEA model. The accuracy of the response in SEA model is greatly dependent on the accuracy of this parameter.

Figure 4 shows the number of modes in a band for all three subsystems. It can be seen in high frequency; the number of modes has become too high, and especially in two acoustic cavities is increasing very rapidly. This is the domain of SEA, because the SEA requires a sufficiently high modal density.

Figure 5 compares the TL obtained from SEA method

with the one obtained from the analytical method. It can be observed that the result of simulating SEA model does not match with the analytical result in low frequency range. Because in low frequency range, modal density of this structure is low and SEA does not predict exact solutions. Also, in high frequency range, analytical method does not predict precise solutions, because in frequencies above 3000 Hz the assumptions of Biot's theory are contravened [22]. However, in the middle frequency range, comparing these two methods

indicates a good agreement. Therefore, in broadband frequency the hybrid method consisting of both of analytical and SEA methods, is proposed which results in reliable estimations.

3. ACOUSTICAL MODELING OF INTAKE SYSTEM USING SEA METHOD

3.1. SEA Modeling

Firstly, the CAD model of the intake system of EF7 engine is imported into AutoSEA2. Then structural and acoustical subsystems and their junctions are

created. The SEA model of this system has 107 subsystems. All intake subsystems are simplified using flat plates and flat shells and only flexural wave transmission is considered. The sketch of this system is shown in Figures 6 and 7.

The intake system is constructed mainly from Polypropylene (PP). The physical properties for Polypropylene are listed in table 3. The subsystems of the intake system vary in thickness from 2 mm to 5 mm.

When carrying out the noise analysis on a component, it is important to understand what force is exciting the component. In order to define the excitation forces properly, three kinds of excitations

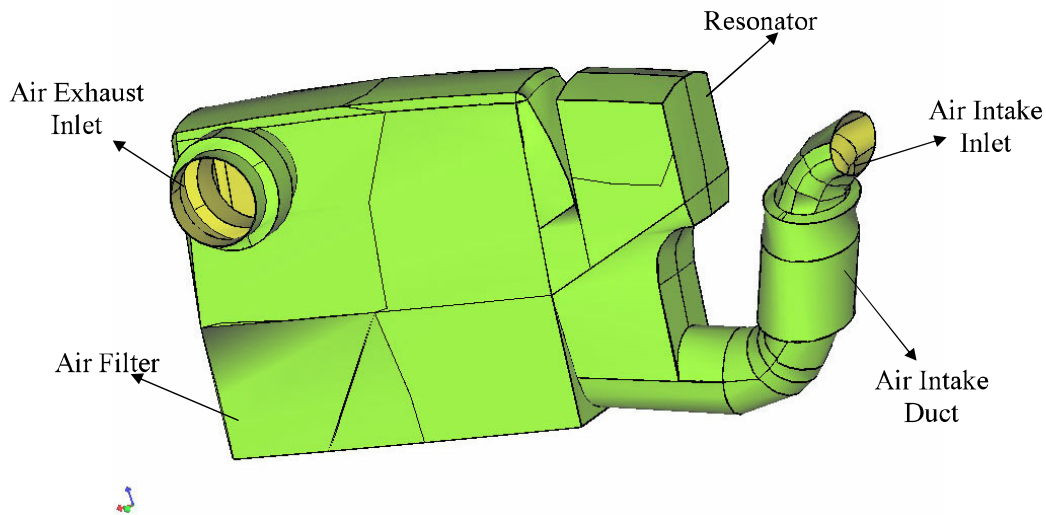

Fig. 6. AutoSEA2 model for Structural subsystems of EF7 intake system

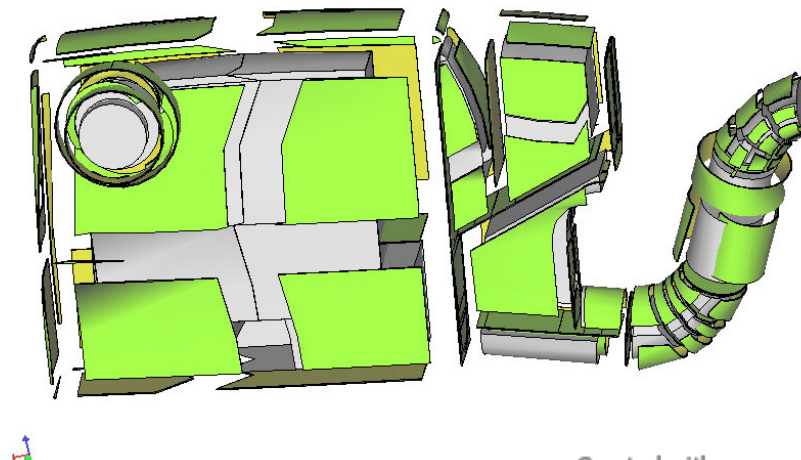

Fig. 7. AutoSEA2 model with internal cavities for EF7 intake system

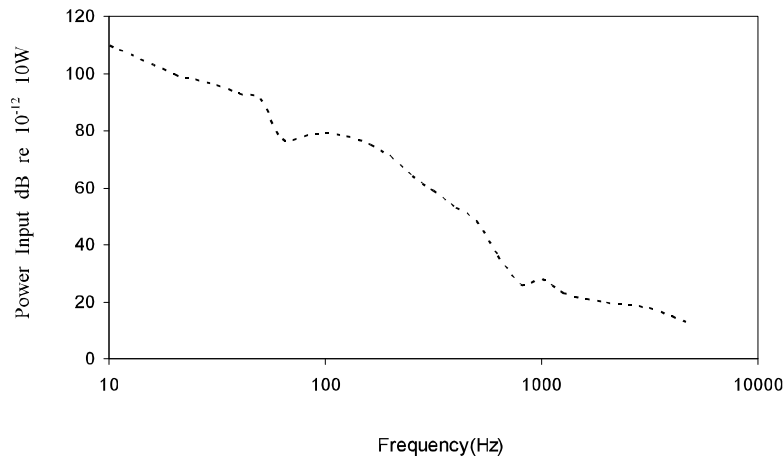

Fig. 8. Measured input power for the engine running at 4000 r/min

Table 3. Physical properties for Polypropylene

physical properties	Polypropylene
Density, ρ ($kg\ m^{-3}$)	905
Tensile Modulus, (Pa)	1.7 e 9
Shear Modulus, (Pa)	6.3 e 8
Poisson coefficient, ν	0.35
Structural Damping, η	0.007

The input power to the car when engine was running at 4000 r/min is measured and the result is shown in Figure 8 After modeling and importing excited forces, the SEA model of intake system can be solved in order to estimate the transmission loss (TL) and sound pressure level (SPL).

3. 2. RESULTS

Figures 9 and 10 compare transmission loss (TL) and the sound pressure level (SPL) obtained from SEA method and experimental results. The comparison indicates the good agreements between the results especially in high frequency ranges.

Polyurethane is treated into the structure in order to study the effects of porous layers on transmission loss. The porous material module in AutoSEA2, based on

are considered here. These excitations are air flow through the intake system, ideal turbulent boundary layer to simulate air flow through outer surfaces intake system and measured input power for intake system.

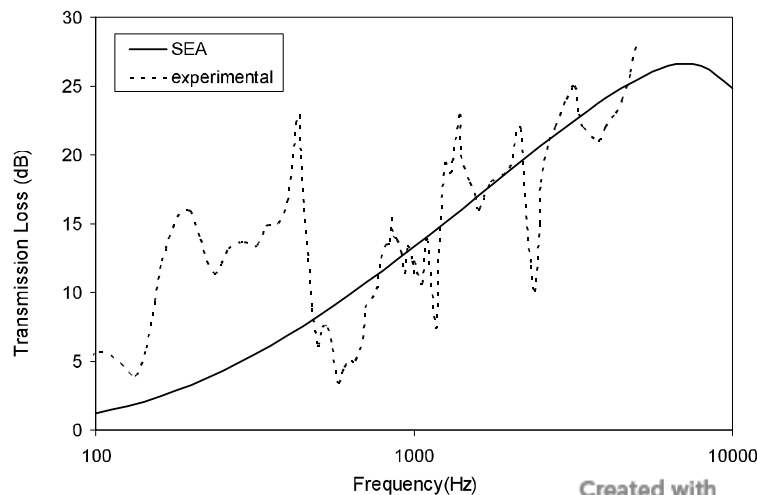

Fig. 9. Comparison of TL between experimental data and SEA model



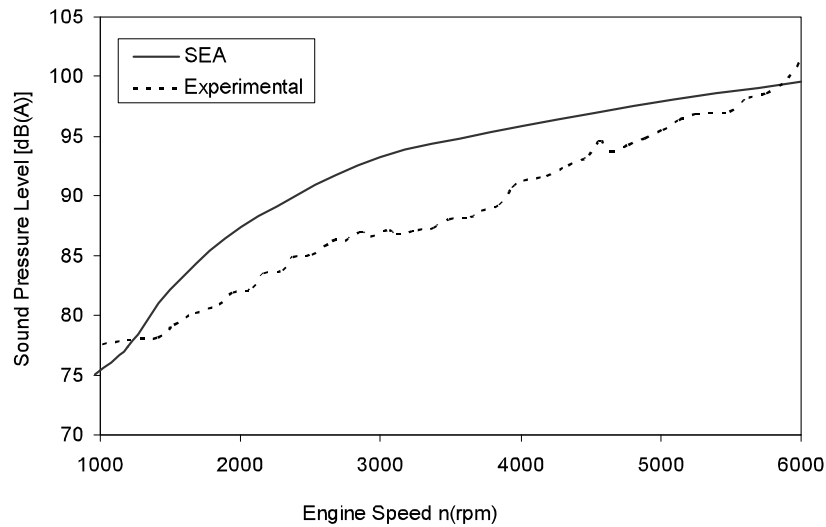

Fig. 10. Comparison of SPL between experimental data and SEA model

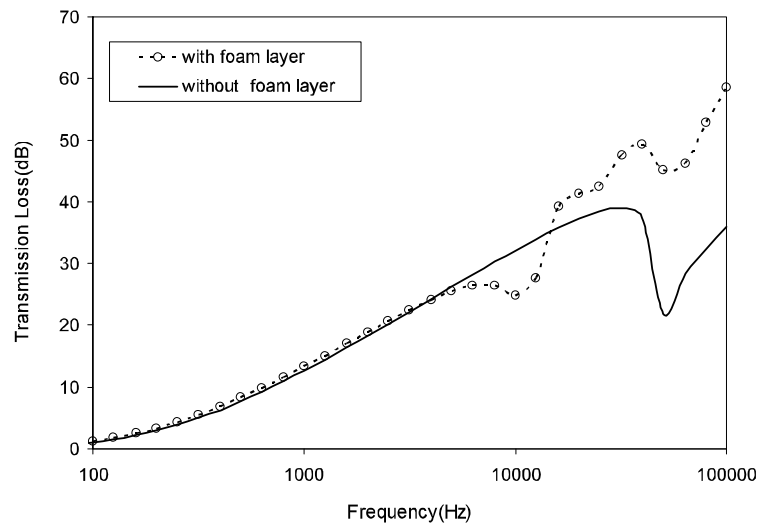

Fig. 11. Comparison of TL for treated and untreated structures

Biot's theory of porous media, is used to predict the structural acoustic effects of porous treatments. Figs. 11 and 12 show the effect of inserting foam on transmission loss and also sound pressure level. As depicted in Figure 11, inserting of porous material make the TL be increased especially in high frequencies. However, its TL suddenly drops around 10000 Hz due to the coincidence effect. As depicted in Figure 12, the SPL is decreased when the foam layer is applied. It should be noted that it is of high interests for automotive and aerospace engineering knowing the characteristics of porous treatment especially in

high frequency ranges.

It is well anticipated that increase of porous layer thickness leads to increase of transmission loss. As illustrated in Figure 13, the overall TL increases 1.5 dB as the thickness of foam doubles. Therefore, a considerable attention should be devoted to porous layer thickness, as it plays an efficient role in noise attenuation especially at high frequency. It should be also noted that increasing the thickness may lead to decrease the coincidence frequency. As depicted in Figure 14, the overall SPL decreases overall 3 dB as the thickness of foam doubles.

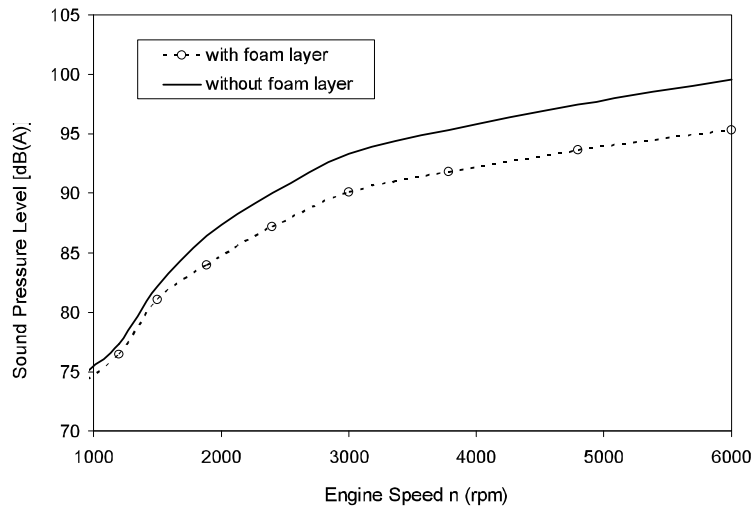

Fig. 12. Comparison of SPL for treated and untreated structures

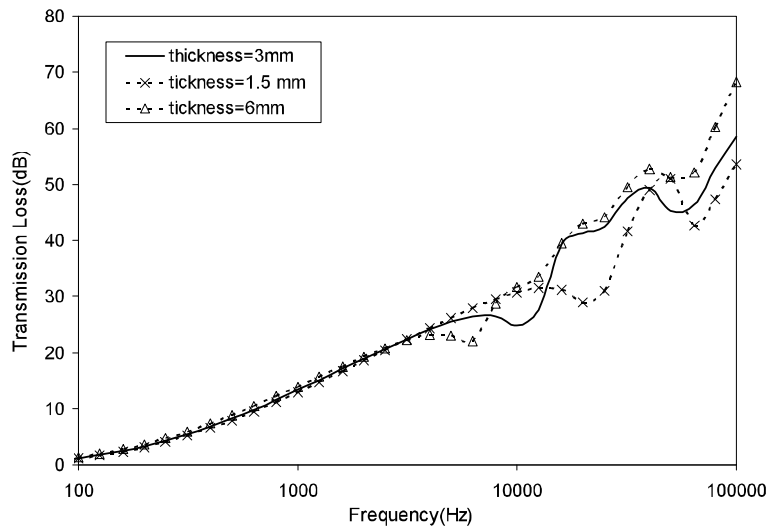

Fig. 13. Comparison of TL for the structures with different thicknesses of foam

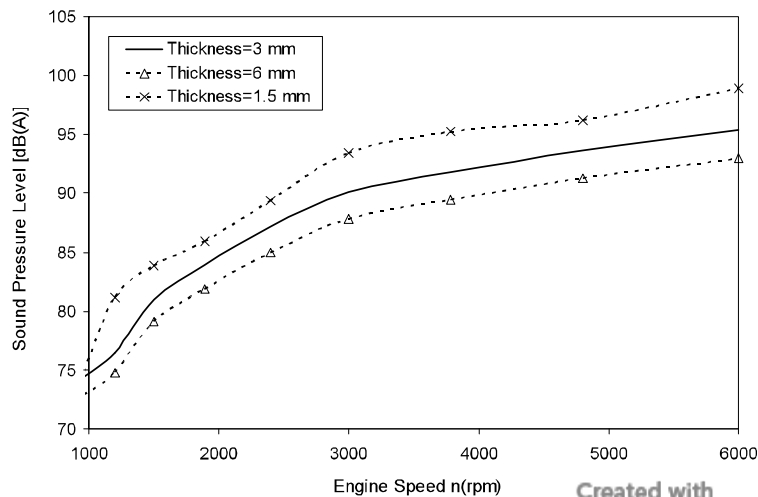

Fig. 14. Comparison of SPL for the structures with different thicknesses of foam

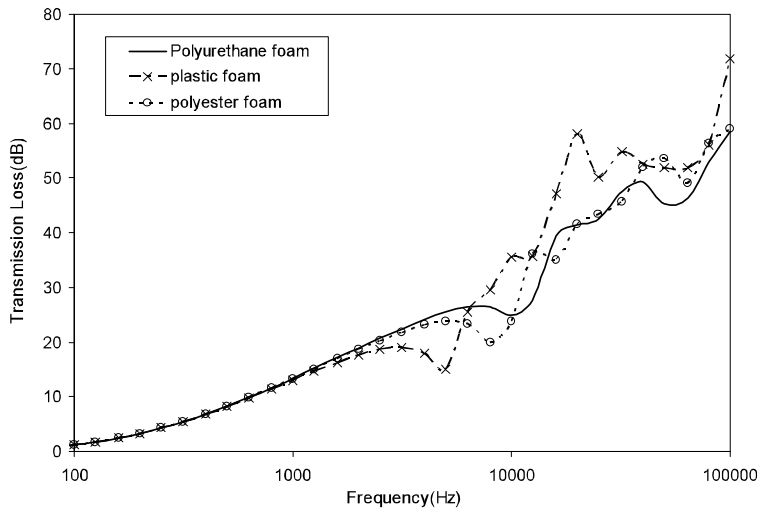

Fig. 15. Comparison of TL for the structures with different sorts of foams

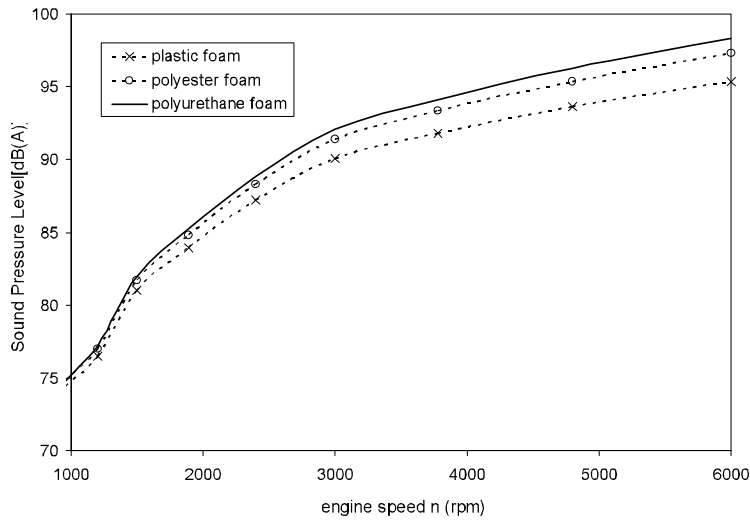

Fig. 16. Comparison of SPL for the structures with different sorts of foams

Table 4. Physical properties for Polyester, Plastic and Polyurethane

Parameters	Polyester	Plastic	Polyurethane
Thickness, (m)	0.03	0.03	0.03
Porosity, h	0.98	0.97	0.9
Flow resistivity, $\sigma(Nm^{-4}s)$	1.35 e 4	8.7 e 4	2.5 e 4
Tortuosity, α_o	1.7	2.52	7.8
Viscous charact. dim, $\Lambda(m)$	8 e -5	3.7 e -5	2.26 e -4
Thermal charact. dim, $\Lambda'(m)$	1.6 e -4	1.19 e -4	2.26 e -4
Young's Modulus, (Pa)	30	31	30
Shear Modulus, (Pa)	5.4 e 5	1.43 e 5	8.008 e 5
Poisson coefficient, ν	0.35	0.3	0.4
Structural Damping, η	0.1	0.055	0.265

Figures 15 and 16 show the effect different sort of applicable foam in automobile industry on TL and SPL. Foams chosen for the comparison are polyester, plastic and polyurethane as shown in table 4. As depicted in Figure 16, using plastic foam has the most effective on decreasing of SPL in high frequency range. This is as expected because the density of plastic is the largest, which makes it most effective in the mass controlled high frequency range.

4. CONCLUSIONS

In this paper, a SEA method was proposed to solve sound transmission through structures with porous liners. The analytical method was developed by Biot's theory. This analysis is performed in the high frequency and high modal density range, where the SEA is a useful and common tool in vibration analysis.

Firstly, the SEA model of double-walled cylindrical shell lined with an elastic porous material such as polyurethane foam is constructed in AutoSEA2 software. The accuracy of the proposed SEA method was checked by comparing the results with those from analysis method and good agreement is observed in a middle frequencies range.

Finally, the detailed model of air intake system treated with porous materials is analyzed using AutoSEA2 software. In addition, the effects of the thickness of duct and foam and difference sort of foam is investigated in the high frequency range.

It is found that transmission loss increases 8% and sound pressure level decreases 3dB as the thickness of foam in duct of intake system doubles.

5. REFERENCES

- [1] Steel, J. A., 1998, "A study of engine noise transmission using statistical energy analysis", Proceedings of the institution of mechanical engineers, ProQuest Science Journals, Vol. 212, Iss. 3, 205- 213.
- [2] Kino, H., Ogasawara, Y., Ito, S. & Komori, T., 2003, "Air Intake Duct and Manufacturing Method Therefor", United State Patent, US 6,622,680 B2.
- [3] Dias T., Monaragala R. and Needham P., 2007, "Analysis of Sound Absorption of Truck spacer Fabrics to Reduce Automotive Noise", Measurement Science and Technology, Vol. 18, pp. 2657-2666.
- [4] Milstead, M. G., 1983, "Vibration analysis of piston engines with application to noise control", Shock Vibr. Dig., 15, 3-13.
- [5] Priede, T., Dixon, J., Grover, E. C. and Saleh, N. A., 1984, "Experimental techniques leading to the better understanding of the origins of automotive engine noise", IMechE Conference on vehicle noise and vibration, C151/84, 141-159.
- [6] Wood, L. A. and Joachim, C. A., 1984, "Vibration of interior noise levels in passenger cars", IMechE Conference on vehicle noise and vibration, C1361/84, 197-209.
- [7] Slevewright, G., 2000, "Air flow noise of plastic air intake manifolds", SAE World Congress, 2000-01-0028, Detroit, USA.
- [8] Kinsler, E. L., Frey, A., Coppens, R. A. and Sander, B. J., 1982, "Fundamentals of Acoustics", John Wiley & Sons. New York.
- [9] Soedel, W., 1993, "Vibrations of Shells and Plates", Marcel Dekker. New York.
- [10] Lee, H., Kim, J. and Kim, H., 2001, "Simplified Method to Solve Sound Transmission through Structures Lined with Elastic Porous Material", J. Acoust. Soc. Am., 110.
- [11] Daneshjou, K., Nouri, A., and Talebitooti, R., 2007, "Sound transmission through laminated composite cylindrical shells using analytical model", Archive of Applied Mechanics, 77(6), 363-379.
- [12] Daneshjou, K., Nouri, A., and Talebitooti, R., 2009, "Analytical model of sound transmission through orthotropic cylindrical shells with subsonic external flow", Aerospace Science and Technology, 13(1), 18-26.
- [13] Pierce, A. D., 1981, "Acoustics", McGraw-Hill. New York.
- [14] Mulholland, K. A., Parbrook, K. D. and Cummings, A., 1967, "The Transmission Loss of Double Panels", J. Sound and Vibration, 6, 324-334.
- [15] Lyon, R. H., 1956, "Propagation of correlation functions in continuous media", J. Acoust. Soc. Am., 28.
- [16] Crocker, M. J. and Price, A. J., 1969, "Sound Transmission using Statistical Energy Analysis", J. Sound and Vibration 9, 3, 469-486.
- [17] Lyon, R. H., 1975, "Statistical Energy Analysis

- of Dynamical Systems: Theory and Applications", M.I.T Press.
- [18] Moor, J. A. and Lyon, R. H., 1991, "Sound transmission loss characteristics of finite sandwich panel constructions", J. Acoust. Soc. Am. 89, 2, 777-791.
- [19] Lyon, R. H., and Maidanik, G., 1969, "Power flow between linearly coupled oscillations", J. Acoust. Soc. Am.
- [20] Allard, J. F., 1993, "Propagation of sound in porous media: modeling sound absorbing materials", Elsevier Science Publishers LTD.
- [21] AutoSEA2 User's Guide, 2004, ESI Group.
- [22] Bolton, J. S., Shiau, N. M. and Kang, Y. J., 1996, "Sound transmission through multi-Panel structures lined with elastic porous materials", J. Sound and Vibration 191, 317-347.